

Mixing Performance study of Impeller Designs and Mixing Tank for Liquid Paste-Type Mixtures

Chon Yu Yun¹, Ummi Noor Nazahiah Abdullah², Othman Norashiken³ and Roshidi Bakar⁴
^{1,2,3}School of Manufacturing Engineering, University Malaysia Perlis, 02000 Arau, Perlis,
Malaysia

⁴Commerce Department, Polytechnic of Sultan Abdul Halim Mu'adzam Shah, Kedah,
Malaysia

Abstract: Mixing operation system using agitated vessels design is a difficult task challenge for liquid-paste type mixtures. The impeller design proven to have great impact to the mixture's homogeneity. The use of Computational Fluid Dynamics (CFD) provide detail understanding for such operation system. Experimental test and computational fluid dynamics simulations were performed in this study to examine the flow characteristic of two impeller designs i.e. anchor and Rushton turbine, in achieving solution for liquid paste-type homogeneity. The impeller was used to mix sodium sulfate granules with warm water. The study objectives are to improve the impeller design for dishwashing paste mixing machine; to find optimum velocity distribution pattern value for liquid-paste type homogeneous mixtures and to remain even dissolve mixtures. The method used in this study are House of Quality (HOQ) analysis and CFD method. The findings are used to provide basis for scale up mixing operation and choosing the best mixing equipment for larger systems.

Key words: *Impeller Design, House of Quality (HOQ), Homogeneity, Computational Fluid Dynamics (CFD), Liquid-Paste Type Mixtures*

INTRODUCTION

Mixing is a fundamental activity in many engineering manufacturing operations fields. Mixing operation in manufacturing industries implies in such food processing, pharmaceutical production, chemical engineering, biotechnology, agri-chemical preparations, paint manufacturing, water purification among countless other applications [1]. Various requirement of production and processing goals has developed a lot of mixing schemes using stirred tanks [2].

In chemical industries, mixing process set-ups numbers of processes. Mixing liquid paste-type soap involves conversion of fat or oil substances into soap and alcohol by the action of heat in the presence of aqueous alkaline. It is made of a compound of natural oils or fats with sodium hydroxide or another strong alkali and typically having perfume and colouring added. It is also known as a highly effective dish cleaning detergent that comes in a paste-type form [3].

In agitation system in stirred vessels, the main objectives is to maintain and ensure a balance quantities of substances in varieties of phases based on concentration levels [4]. Stirrer is used to increase the interaction of substance particles and to avoid uneven mixtures at one point, in soluble solid mixing cases [5]. Velocity flow streams in stirred vessels are recognized to be turbulent, chaotic and difficult to determine; therefore, attaining homogeneity in such mixing approaches is a worrying task. Achieving uniform concentrations of blending merchandise is paramount for efficient and cost-efficient use of the high-priced chemicals, fertilizers and other mixing marketers in soap industries applications. An essential choice of equipment that generates enough turbulence and flow inside the blending vessel is consequently necessary.

The inconsistencies in mixing quality may attributed by lack of know-how to mix procedures due to the complicated nature of impeller-triggered turbulence in agitated vessels [6]. There is a need for in-depth study to determine mixing efficiency and accuracy to predict

the general overall performance of those systems. Previous studies has proven that a performance of mixing processes could be determine by product mixing time, types of impeller used, number of impeller blades, blade size, operating angular speeds, and vessel configurations [7].

In large-scale manufacturing mixing plants, complete agitation set-up and suitable stirrers should be capable of create faster motion of mixture particles in excessive turbulence. This makes the whole mixing process in large tanks to be complex and impractical to look at via experiments [8]. There is consequently a need to offer more practical method to simplify the process.

Quality Function Deployment (QFD) has been widely known to be very useful tools for service and customer-driven product development [9][10]. It has been applied effectively in various fields. Some recent examples of its programs are in ERP device selection, shipping investment decision making, semiconductor device-on-a-chip product layout planning, and approaches selection [9,11,10]. The core advantages of using QFD is capability of the tools to translate the customer needs into coherent translation and substitute these wishes into each phase of product development process. Since its far used by and large in early level of products or services development process, this paper will focus to propose target specification of impeller design using dynamic QFD tools. Customer need and requirement has been translated into product target specification.

Computational fluid dynamics (CFD) is instrumental tool to analyze fluid float structures using numerical methods and simulations in a computer-aided programs. Using CFD, engineers could easily study new and complicated models in virtual environments, determine the design details, predict possible sources of failure and optimize gadget operations. Furthermore, many researchers and industrialists conceded beneficiary of CFD in decreasing the price and time spent in creating huge and complicated prototypes of trial system phase. Quality and crucial information may be received inside a small working vicinity and with less effort with CFD application.

To obtain an excellent mixing result, CFD is a prominent tool to gain in-depth understanding of turbulent dynamics of mixing process in stirred tank. Using CFD, the outcomes of numerous and abnormal configuration of mixing tank, impeller design and baffles can be modelled through numerical simulations. The overall performance in large scale tank can be projected and predict under severe working condition [12]. Some of the integration parameters which have been investigated the use of numerical methods in CFD consist of mixing times, power requirements, flow

types, and velocity patterns [13]. Impeller design is the most vital factor to evaluate the routine performance in agitated mixers [14]. Numbers of researcher has conducted CFD assessment to look in-depth outcome of impeller types in mixing tank. The design functional operational characteristic can be described in theoretically using CFD. Deglon [15] did simulations of impeller flow pattern in stirred tanks using CFD to evaluate the velocity flow and mixing time. Tatterson [4] emphasized the significance of numerically modelling in actual impeller flow characteristic.

The aim of this study is to use QFD to identify and propose accurate target specification of impeller design for liquid paste-type mixtures and to implement CFD method to analyze mixing behavior of different impeller design. This will add a value knowledge of choosing the best mixing impeller design to meet the mixtures requirement. It was also expected. It was also anticipated that this work would deliver a justifiable foundation for accurate scale-up of blending structures in industrial field mixing operations.

In this study, 4 different types of impellers: anchor, counter-drift, saw-tooth, and Rushton turbine impellers have been studied to determine the target characteristic and design specification for liquid-paste type impeller design using QFD. A final design proposal is designated in combination of saw-tooth and Rushton turbine impeller design. Experimental tests were accomplished to offer a comparative reference to the current impeller to obtain a simulation result. Velocity profiles generated in CFD were interpreted as the impeller flow pattern. Simulations were done using commercial software, ANSYS Fluent 18.1 solver.

METHODOLOGY

Research Methodology Flow

Customer satisfaction is leading a growing concern to all company around the world. Satisfaction rating is used to be as a performance indicator for product and services for a successful company. Product expectation mentioned by customer previously remain only the tip of the iceberg. Using QFD method, customer need can be translated into engineering parameter value that can be measure, eliminated, improved or substitute. The customer need is evaluated into House of Quality by analyzing customer problems via Kano's Model [9].

In this study, study flow steps of the 'Kano Project' is used to evaluated four operators in mixing production line of liquid soap paste-type company as shown in Fig 1.

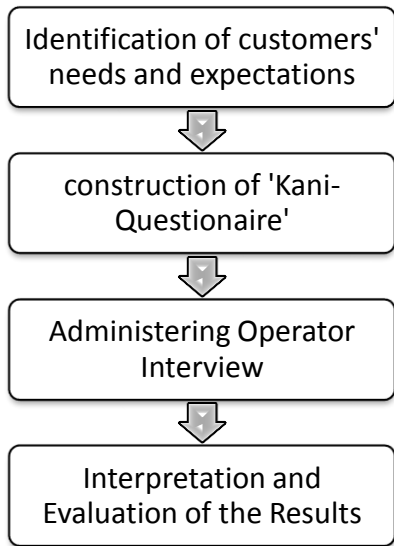

Fig 1: Study flow of the ‘Kano Model Project’

QFD is a customer-oriented approach in product development. Product development is outlined in step-by-step approach determined in relationship matrix in HOQ as illustrated in Fig 2. Please noted that we base our example on a current limited number of product requirements and a restricted number of design attributes. A target specification of impeller design and mixing tank was proposed as a result of HOQ. The target specification parameter values give a justifiable basis for accurate scale-up of mixing systems to proposed better design. QFD is vital to collect Voice of Customers (VOC), established the results into HOQ and translate the customer demand into technical requirement including target specification and design attributes ultimately affected the manufacturing process parameters.

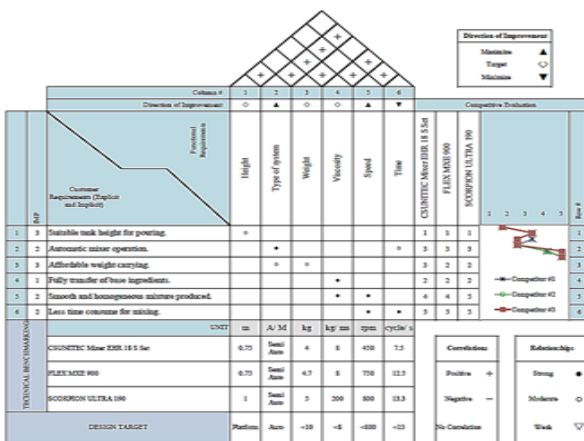

Fig 2 House of Quality (HOQ)

Based from the target specification values, design development continues in next method by implementing morphological chart tools. More than 75% design

activities fall into design modification, variant design or case-study design classifications [16]. Morphological chart was constructed without filtering any mechanism. Any possible solution and options are considered. The concurrent deployment is tailored to meet the needs of product variant design [16].

Design Aspect	Idea 1	Idea 2	Idea 3	Idea 4
Impeller Design				
Shaft Design				
Tank Design				
Concept Chain	Inclined Blade, Shaft with Blade and Round Bottom Tank	Marine Propeller, Shaft with Blade and Round Bottom Tank	Cowles Disc, Hollow Shaft and Cone Bottom Tank	

Fig 2 Morphological Chart

The product development process continues by implementing concept generation phase where the sketched ideas was linked with the aid of morphological chart showed as Figure 2. The concepts generated then evaluated by screening and scoring process, which finally the result produce a final concept. The final concept will be developed into a conceptual drawing in computer-aided-design to implement the proposed idea, shown in Fig 3.

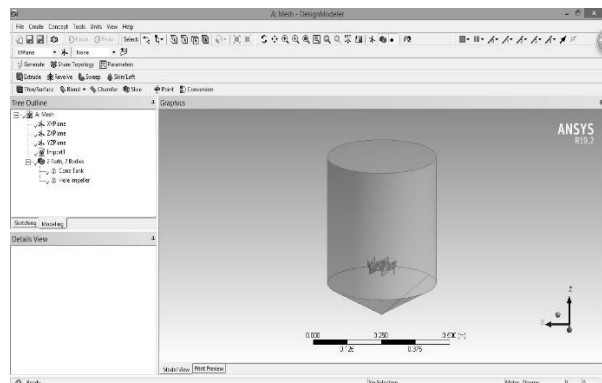

Fig 3 Conceptual Drawing geometry in Design Modeler.

The next step is analyzing velocity pattern using CFD. Fig 4 showed CFD simulation is done as the last step to analyze the fluid flow brought by the improved mixer design. The simulation is carried out using ANSYS Fluent software. Sliding mesh method is involved to indicate the velocity streamlines in mixing process.



Fig 4: CFD Simulation using Ansys

RESULT AND DISCUSSION

The results of target specification outcome from HOQ analysis is shown in Table 1. The specifications of the mixer are being developed, evaluated and studied starting from the interpretation of customer needs until the generation of House of Quality. These specifications are listed in Table 1 with their corresponding units and targets to achieve during design phase. These specifications can be a guideline in designing an ideal mixer that fulfils the requirements for liquid soap paste-type mixing machine.

Metric	Unit	Target Specifications
Height	m	Platform
Type of system	Automatic/ Manual	Semi-Automatic/ Automatic
Weight	kg	<10
Viscosity	kg/ m s	<8
Speed	rpm	<800
Time	Cycle/ s	<13

Table 1: Target specification for the impeller and mixing tank system

Fig 5 shows the final concept generated after the screening and scoring process. The concept is a combination ideas from current design and improved

design.

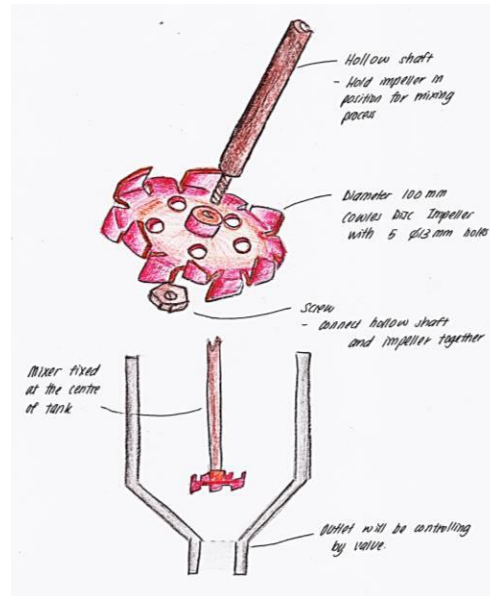

Fig 5: Final concept design proposal of mixing tank and impeller.

Fig 6 illustrates the exploded view of improved mixing machine design. Hollow shaft is selected as the connecting part between impeller and machine motor. Next, cowles disc impeller has redesigned with 5 holes on the surface. The holes designed to allow sodium sulphate and warm water particles to flow through for a better mixing between upper and lower regions of impeller. This mixer design is matched with a cone bottom tank that with a better mixing and transferring geometry.

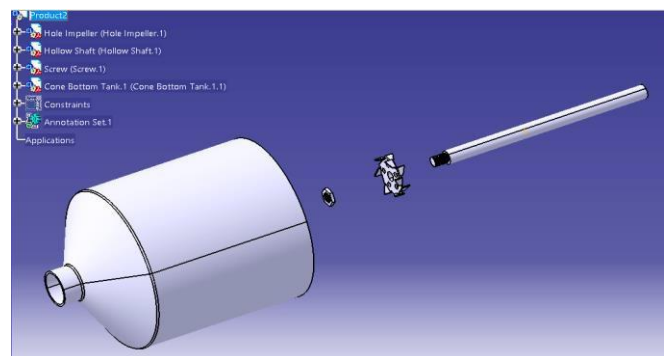

Fig 6: Proposed conceptual drawing in Computer-Aided-Design.

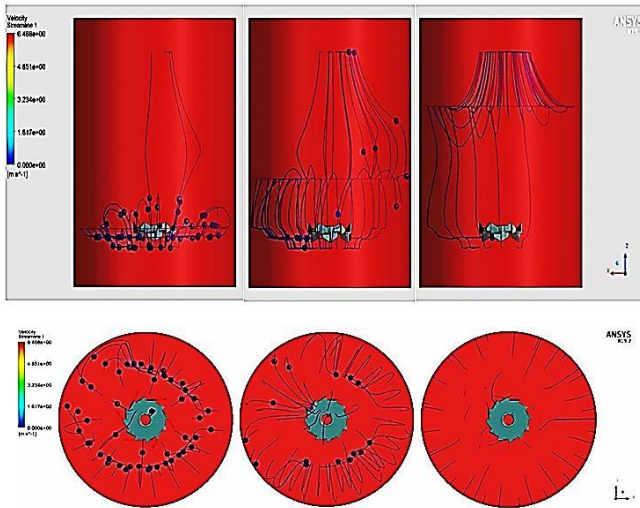

Fig 7 Velocity Streamline results of current mixer design.

Figure 8 showed the velocity streamline results of current mixing machine design. Combination of cowles disc impeller with flat bottom tank have resulted in non-homogeneous mixture. This is because of the geometry of flat bottom tank where the cowles disc shows that the blade drove the fluid to the wall, which splashed back in opposite direction due to the large center in the tank. This type of impeller does not efficient in distributing liquid paste-type mixtures over the tank. The impeller has only created a small mixing range around itself. The sodium sulphate has formed as lump and deposited at bottom of the tank.

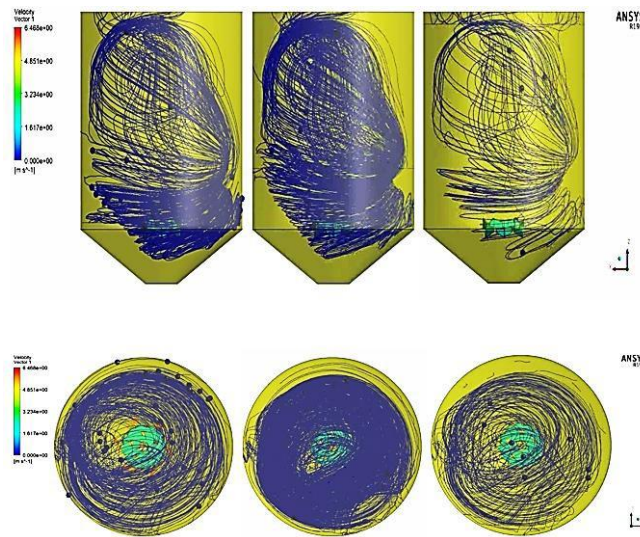

Fig 8 Velocity streamline results of improved mixer design.

Figure 9 showed the streamline results of improved mixer design. Combination of cowles disc impeller with holes and cone bottom tank have brought more velocity streamlines that result outcome showed more homogeneous mixture was developed. The slope surface in the geometry of cone bottom tank has helped in producing circled streamline within the tank. Sodium sulphate from the upper mixing range can circulate and passed through the holes on the cowles disc impeller. Hence, this aided in sweeping the ingredients completely from the corner of the tank bottom. With the increment of velocity streamlines within the tank, more sodium sulphate has mixed with warm water and yet less lump deposited at bottom of the tank.

Parameters	Unit	Current Mixer Design	Improved Mixer Design
Mass Flow Rate	kg/s	0.00280	0.04803
Volumetric Flow Rate	m ³ /s	0.000003	0.000048
Flow Rate with Density Based	kg ² /m ³ s	2.83	47.94
Pathlines	-	257448	976450

Table 2: Comparison of parameters results for current design mixing system design and improved mixing system design.

Table 2 indicates the summary comparison of parameters results from the simulations. With density based, the flow rate of improved mixer design is greatly increased compared to that of original mixer design by 45.11 kg²/m³s. Pathlines brought by improved mixer design is also raised compared to that of original mixer design by 719002.

Finally, with the same settings for simulation purpose, the improved mixer design has proven creating more velocity streamlines and larger mixing range compared to that of current mixing system design. The improved design of mixer and geometry of heating tank shown effective performance in homogeneity factor of mixtures.

CONCLUSION

The improved mixer is a combination of hollow shaft, cowls disc impeller with holes and cone bottom tank. This geometry of mixer has affected much in homogeneity for liquid pate-type mixtures. The results presented as fluid flow simulation where improved mixer design has shown increase of velocity streamlines and larger mixing range compared to that of current mixing system design.

ACKNOWLEDGMENTS

The authors acknowledge Fennek Global Sdn Bhd for industrial support case study.

REFERENCES

- [1] R. R. R. Zadghaffari, J.S Moghaddas, "A Study on Liquid Mixing in a stirred tank with 6-blade rushton turbine," *Iran. J. Chem. Eng.*, vol. 5, no. 4, 2008.
- [2] J. Aubin, S. M. Kresta, J. Bertrand, C. Xuereb, and D. F. Fletcher, "Alternate Operating Methods for Improving the Performance," *Trans IChemE*, vol. 84, no. A4, pp. 569–582, 2006.
- [3] S. Drive, W. Chester, O. H. U. S. Read-, and M. U. S. Us, "Wo 2011/084569," 2011.
- [4] G. B. Tatterson, "Fluid mixing and gas dispersion in agitated tanks," in *McGraw-Hill: New York, NY, USA*, vol. 29, no. 02, 1991, pp. 29-0927-29-0927.
- [5] A. T.-C. Mak, "Solid-liquid mixing In Mechanically Agitated Vessels," 1992.
- [6] R. Raju, S. Balachandar, D. F. Hill, and R. J. Adrian, "Reynolds number scaling of flow in a stirred tank with Rushton turbine. Part II - Eigen decomposition of fluctuation," *Chem. Eng. Sci.*, vol. 60, no. 12, pp. 3185–3198, 2005.
- [7] I. M. Poley and L. S. Oliveira, "CFD modeling and simulation of transesterification reactions of vegetable oils with an alcohol in baffled stirred tank reactors," *Appl. Mech. Mater.*, vol. 390, pp. 86–90, 2013.
- [8] and M. M. Seyed Hosseini, Dineshkumar Patel, Farhad Ein-Mozaffari, "Study of Solid-Liquid Mixing in Agitated Tanks through Computational FluidDynamics Modeling," *Ind. Eng. Chem. Res.*, vol. 49, no. 9, pp. 4426–4435, 2010.
- [9] K. Matzler and H. H. Hinterhuber, "How to make product development projects more successful by integrating Kano's model of customer satisfaction into quality function deployment," *Technovation*, vol. 18, no. 1, pp. 25–38, 1998.
- [10] B. Bergman, B., & Klefsjö, "Quality from customer needs to customer satisfaction.," *Student Lit. Lund, Sweden*, 2003.
- [11] H. Raharjo, M. Xie, and A. C. Brombacher, "A systematic methodology to deal with the dynamics of customer needs in Quality Function Deployment," *Expert Syst. Appl.*, vol. 38, no. 4, pp. 3653–3662, 2011.
- [12] D. G. M. P. D. P. A. R. S. M. J. Alvare, "CFD-based compartmental modeling of single phase stirred-tank reactors," *Am. Inst. Chem. Eng.*, vol. 52, no. 5, 2006.
- [13] L. Pakzad, F. Ein-Mozaffari, and P. Chan, "Using computational fluid dynamics modeling to study the mixing of pseudoplastic fluids with a Scaba 6SRGT impeller," *Chem. Eng. Process. Process Intensif.*, vol. 47, no. 12, pp. 2218–2227, 2008.
- [14] C. Y. Ge, J. J. Wang, X. P. Gu, and L. F. Feng, "CFD simulation and PIV measurement of the flow field generated by modified pitched blade turbine impellers," *Chem. Eng. Res. Des.*, vol. 92, no. 6, pp. 1027–1036, 2014.
- [15] D. A. Deglon and C. J. Meyer, "CFD modelling of stirred tanks: Numerical considerations," *Miner. Eng.*, vol. 19, no. 10, pp. 1059–1068, 2006.
- [16] C. H. Lo, K. C. Tseng, and C. H. Chu, "One-Step QFD based 3D morphological charts for concept generation of product variant design," *Expert Syst. Appl.*, vol. 37, no. 11, pp. 7351–7363, 2010.